



DD Domestic Pumps



DDP



DDC



DDS



DDJ



DDG

Installation & Operating Manual

INDEX

1. PUMP SPECIFICATIONS	1
2. INSTALLATION	3
3. ELECTRICAL CONNECTIONS	4
4. PRIMING	4
5. MAINTENANCE	5
6. TROUBLE SHOOTING	6
7. WARRANTY	7

Congratulations on selecting a Dayliff Domestic Pump. They are manufactured to the highest standards and if installed and operated correctly will give many years of efficient and trouble free service. Careful reading of this Installation Manual is therefore important, though should there be any queries they should be referred to the equipment supplier.

1. PUMP SPECIFICATIONS

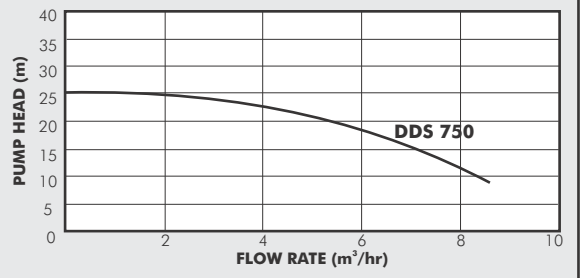
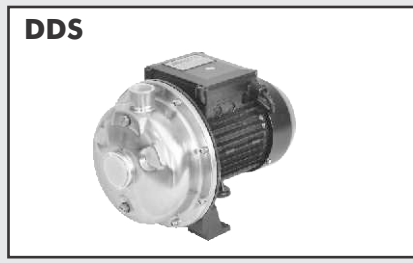
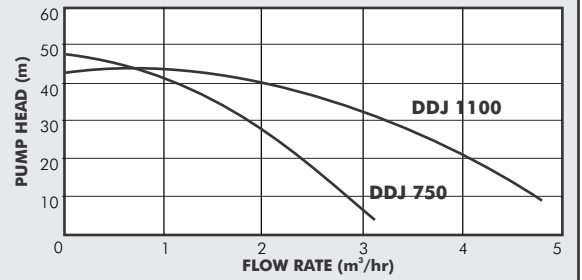
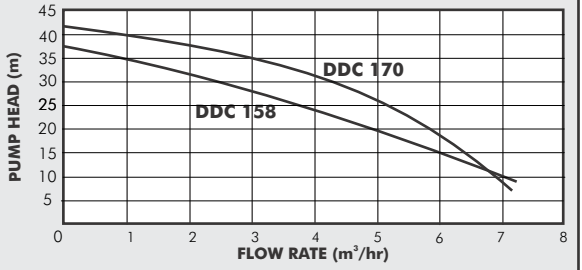
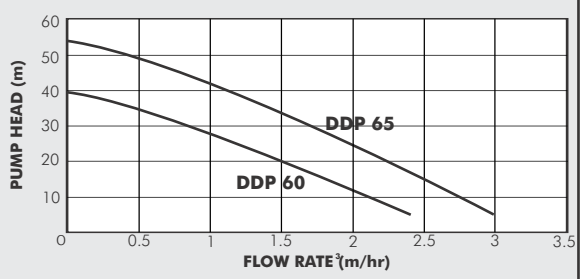

DDG

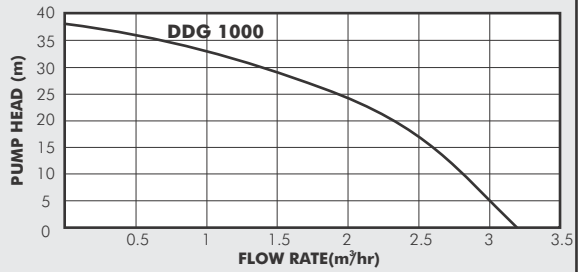

PUMPS

The Dayliff DD pump range is specially designed for all small scale domestic and commercial water supply uses. Model options are available as follows:

DDP: High specification peripheral pumps that features copper windings, a high capacity motor and stainless steel housing inserts to ensure free impeller movement. The pump body is manufactured from cast iron and the impeller from brass.

DDC: Centrifugal non-self priming closed impeller pumps particularly suited for water boosting and transfer applications. The pump body is cast iron and the impeller stainless steel for DDC 158 and brass for DDC 170.

DDJ: Centrifugal jet type pumps that incorporate an integral ejector unit to provide highly effective self priming performance. The pump body is made from cast iron, the ejector from engineering plastic and impeller from brass.

DDS: Centrifugal single impeller non-self priming pump. The pump body, backplate and impeller are made from 304 stainless steel.

DDG: Single stage centrifugal impeller self priming design. Materials of construction are stainless steel for the pump body, shaft and back plate with the impeller made from polypropylene.

MOTORS

Pumps are close-coupled to reliable TEFC electric motors designed for continuous operation and are provided with a thermal cutout to protect against electrical overload. They can be connected directly to the mains power supply through a 10A fuse or MCB.

Pump Data

Pump	Power		Dimensions (mm)					Weight (kg)
	kW	Current (A)	DN1	DN2	L	W	H	
DDP60	0.37	2.5	1"	1"	265	118	151	5.3
DDP65	0.75	5.2	1½"	1½"	305	136	181	10
DDC158	0.75	5.2	1"	1"	305	190	260	13.8
DDC170	1.1	7	1½"	1½"	345	230	293	21
DDJ750	0.75	5.2	1"	1"	435	191	200	17
DDJ1100	1.1	7	1½"	1"	515	209	218	32
DDS750	0.75	5.2	1¼"	1"	315	213	232	14
DDG1000	0.8	2.5	1"	1"	336	201	244	7

2. INSTALLATION

- Site in a dry, well ventilated and weather proof location with an ambient temperature of no more than 40°C.
- Locate on a solid flat surface ensuring the shaft is in a horizontal position.
- Ensure that the diameter of the suction pipe is at least the size of the pump suction inlet. If the suction depth exceeds 4 meters then a one size larger diameter pipe should be used, though for maximum pump performance suction height should be minimised.
- If there is negative suction (i.e. the pump is above the suction water level) the suction pipe must be slightly angled upwards towards the pump inlet to avoid the formation of air locks. It must also be immersed in water by at least 0.5m to avoid the formation of vortices and a good quality foot valve must be fitted.
- Ensure that all suction pipe connections are completely airtight or else the pump will not operate. The diameter of the delivery pipe must be chosen to suit the flow rate and pressure required at the delivery point though must not be smaller than the pump outlet size. It is also advisable to fit a non-return valve and isolating valve on the delivery outlet. This measure is essential if the delivery pressure exceeds 20 meters.

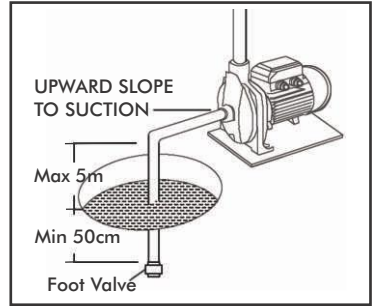

3. ELECTRICAL CONNECTIONS



The installer is responsible for making electrical connections to the mains supply in compliance with relevant local regulations. Ensure that a professional electrician carries out the electrical connections and that the following guidelines are followed:-

- All installations must be provided with an isolator to cut off mains power supply and coarse current protection in the form of a fuse or MCB rated at 2-3 times the full load current as given on the pump plate.
- Ensure that the power supply rating complies with the specification on the pump rating plate.
- Electrical connections must be made according to details in the pump junction box cover and effective earthing must be provided according to local regulations.
- Single-phase motors are protected against overloads by a thermal overload fitted in the motor windings.

4. PRIMING

All non-self priming pumps must be primed before operation. To do this completely fill the pump housing with clean water through the priming plug before switching it on. When full replace the priming plug and start the pump checking there is a steady flow at the pump outlet. The pump should be primed whenever it has not been used for a long period of time or when air has entered into the system.

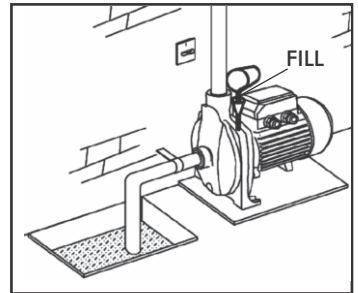

Serious damage will occur if a pump is not properly primed and runs without water.

5. MAINTENANCE

Pumps do not require routine maintenance provided the following precautions are taken:-

- Check that the foot valve is clean and unrestricted at regular intervals.
- If the pump is to remain unused for long periods of time it is advisable to empty it completely, rinse it with clean water and store in a dry place.
- If the shaft does not run freely, release it using a screwdriver by inserting it in the special slot on the rear of the pump shaft. If this is not sufficient to solve the problem remove the pump body by unscrewing the relevant mounting bolts and clean it thoroughly to remove any encrustation.



Never carry out any work on the pump without having first disconnected from the mains supply.

6. TROUBLE SHOOTING

PROBLEM	POSSIBLE CAUSE	SOLUTION
Motor won't start	No Power	Check connections and power supply
	Impeller stuck	See section on maintenance
Motor turns without pumping	Delivery head exceeds pump capacity	Reduce delivery head Specify different pump
	Clogged foot valve	Clean foot valve
	Excessive suction height	Move pump closer to water level
	Air in suction	Check suction pipe is airtight
		Make sure foot valve is immersed by at least 50cm
Pump needs to be primed		
Flow rate insufficient	Suction height at limit	Reduce suction height
	Foot valve partially clogged	Clean foot valve and, if necessary whole Intake pipe
	Impeller blocked	Disassemble pump and carefully clean pump body and impeller
Tripped motor overload	Overheated motor	Check voltage and ventilation
	Impeller stuck	Release impeller (See section on maintenance)

7. TERMS OF WARRANTY

i) General Liability

- In lieu of any warranty, condition or liability implied by law, the liability of Davis & Shirliff (hereafter called the Company) in respect of any defect or failure of equipment supplied **is limited to making good by replacement or repair** (at the Company's discretion) defects which under proper use appear therein and arise solely from faulty design, materials or workmanship within a specified period. This period commences **immediately after the equipment has been delivered to the customer** and at its termination all liability ceases. Also the warranty period will be assessed **on the basis of the date that the Company is informed of the failure.**
- This warranty applies solely to equipment supplied and **no claim for consequential damages**, however arising, will be entertained. Also the warranty specifically excludes defects caused by fair wear and tear, the effects of careless handling, lack of maintenance, faulty installation, incompetence on the part of the equipment user, Acts of God or any other cause beyond the Company's reasonable control. Also, any repair or attempt at repair carried out by any other party **invalidates all warranties.**

ii) Standard Warranty

General Terms

If equipment failure occurs in the normal course of service having been competently installed and when operating within its specified duty limits warranty will be provided as follows:-

- **Up to two years - The item will be replaced or repaired at no charge.**
- **Over two years, less than three years - The item will be replaced or repaired at a cost to the customer of 50% of the Davis & Shirliff market price.**

The warranty on equipment supplied or installed by others is conditional upon the defective unit **being promptly returned free to a Davis & Shirliff office** and collected thereafter when repaired. No element of site repair is included in the warranty and any site attendance costs will be payable in full at standard chargeout rates.

Also proof of purchase including the purchase invoice must be provided for a warranty claim to be considered

DAYLIFF is a brand of **Davis & Shirliff**

for enquiries contact

Davis & Shirliff, Ltd.

P.O. Box 41762 - 00100, Nairobi, Kenya

Tel: 6968000/ 0711 079 000

or visit

www.dayliff.com

for details of the nearest branch or stockist